

ABSOLUTE DIGIMATIC SCALE UNITS

Catalog No. E4316-572



ABSOLUTE Digimatic Scale Units

Strengthened lineup includes new coolant-proof models and incorporates absolute scale technology throughout

ABSOLUTE Digimatic Scale Units

Horizontal single function type



572-202-20

Horizontal multi-function type



572-461

Vertical single function type



572-303-10

Vertical multi-function type



572-561

Absolute functions

- Absolute scale technology prevents overspeed errors.
- The coordinate origin (ABS point) can be set to desired position and stored. A previously set ABS point is retained even when the power is off, so the current true position is displayed immediately after power-on.

Note: The ABS point reverts to the default value when the battery is removed or replaced.

Long battery life

- Single function types feature very long battery life (about 20,000 hours), thus providing lower-cost operation and environmental benefit. (Coolant-proof type: about 15,000 hours)

Small and light

- Smaller display unit allows use as a positioning sensor for jigs and tools as well as on small machine tools.

ABSOLUTE Coolant-proof Digimatic Scale Units

Horizontal single function type



572-602



572-601



IP66 protection code compliant (ABSOLUTE Coolant-proof Digimatic Scale Units only)

- Featuring absolute scale technology with a new detection method (electromagnetic induction^{*1*}^{*2}) that makes the unit usable in hostile environments where it is exposed to water or coolant spray.

*1: For details of the electromagnetic induction detection method, see page 5.

*2: Patents registered in Japan, the USA and Europe (Germany, the UK, France and Switzerland). Patents pending in India and China.

- Position data can be output to external devices using the waterproof connecting cable dedicated to ABSOLUTE Coolant-proof Digimatic Scale Units.



Typical applications

Machine table positioning

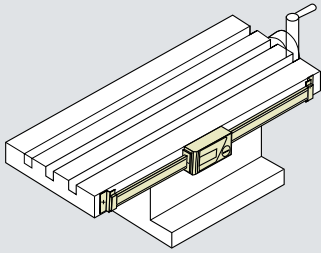

Drilling machine stroke position

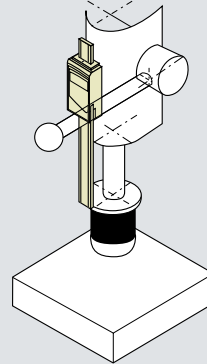

Tool presetting

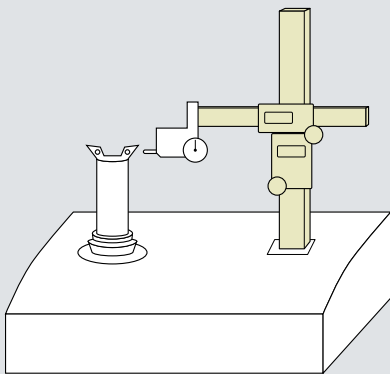

Focus setting on optical instruments

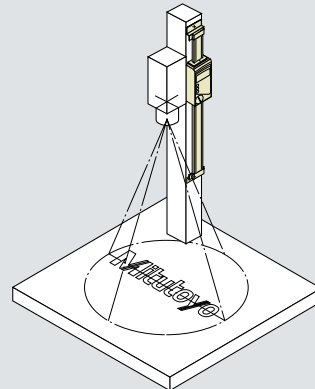

Special applications

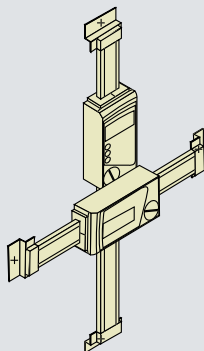

XY coordinate measurement

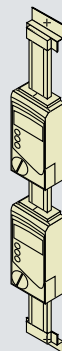

Multi-head applications

Non-standard units can be made to special order. Contact your local sales office for more information.

System diagram

Scale units

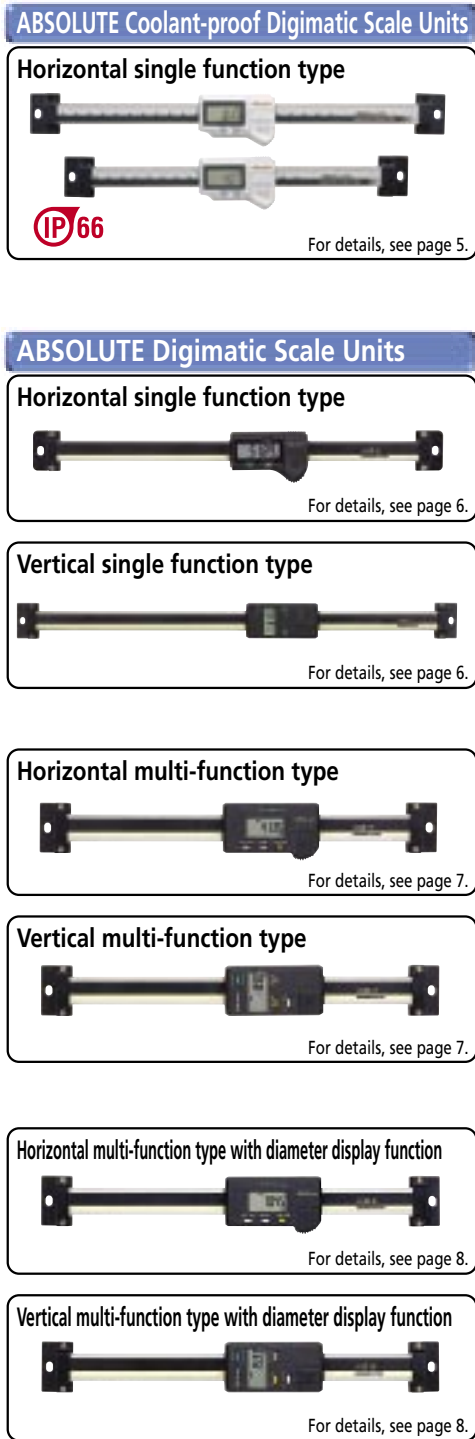

Display units and peripheral devices

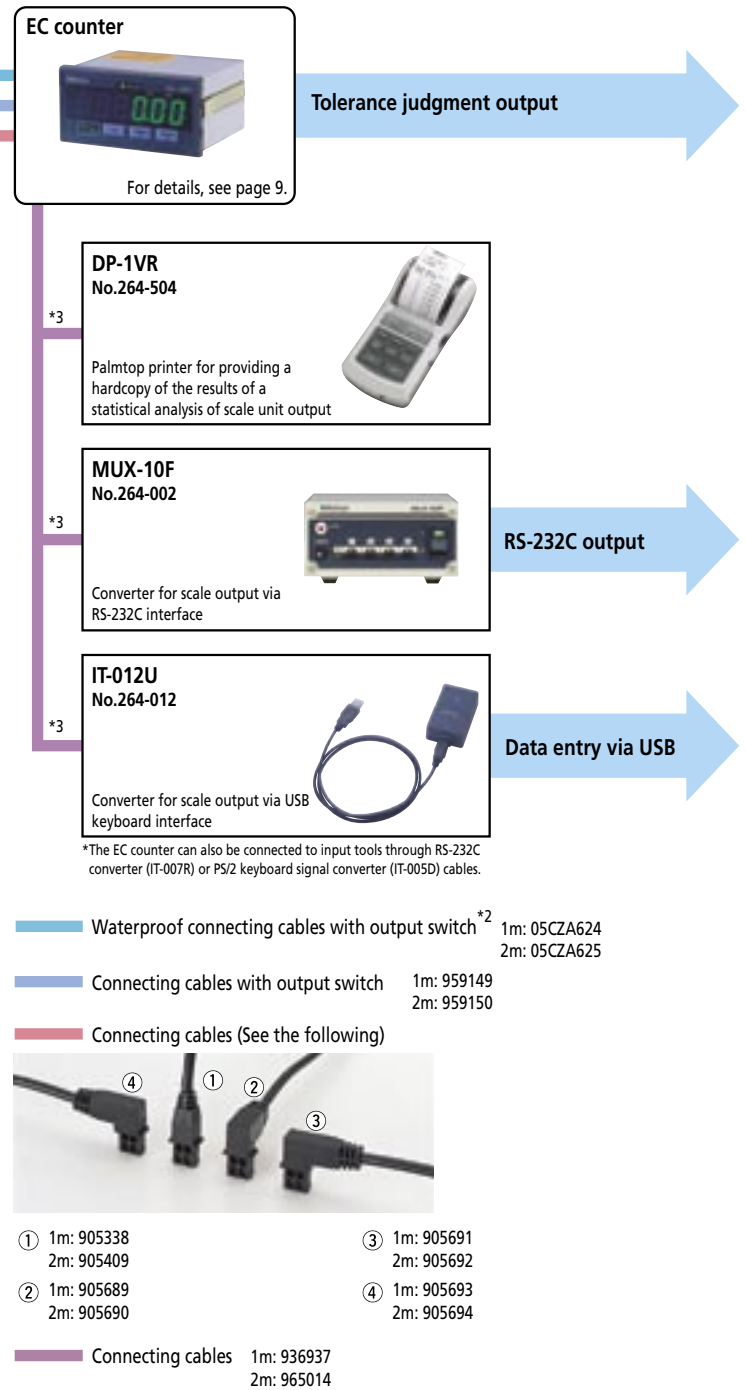

*1: Tolerance judgment or Digimatic is selected as an output when setting parameters.
 *2: Waterproof connecting cable with output switch can be used only for ABSOLUTE Coolant Proof Digimatic Scale Units.
 *3: All scale units can also be used by connecting them directly to the DP-1VR, MUX-10F or IT-012U, not through the EC counter. In such cases, use a cable that connects the scale unit with the EC Counter.

Scale unit functions

Function	Type Function Symbol	ABSOLUTE Coolant-proof Digimatic Scale Units	ABSOLUTE Digimatic Scale Units		
		 Horizontal single function type	Horizontal single function type Vertical single function type	Horizontal multi-function type Vertical multi-function type	Horizontal multi-function type with diameter display function Vertical multi-function type with diameter display function
ABS point setting	ORIGIN	✓	✓	✓	✓
Zero-setting	ZERO	✓	✓	✓	✓
Direction changeover	DIR	-	-	✓	-
Presetting	PRE	-	-	✓	✓
Display holding	HOLD	-	✓✓	✓	✓
Data output	M-SPC	✓	✓	✓	✓
Diameter display	Dia.	-	-	-	✓
Alarm for faulty counting	E	✓	✓	✓	✓
Low battery-voltage alarm	B	✓	✓	✓	✓

✓ Standard feature ✓✓ A hold switch (option: No. 959143) must be used.

*In all scale units, switching between ABSOLUTE Mode and Incremental Mode is possible.

The ZERO/ABS key allows the display to be zero-set at any slider position along the beam for incremental comparison measurements.

This key also allows return to ABSOLUTE Mode with a display of the true position from the origin point.

Highly robust design. The Digimatic scale is safely embedded in a hardened, stainless steel bar.

The following is a brief description of each function.

ORIGIN

ABS point (0.00) can be set to the desired point and stored.
Can be used only when the unit is in ABSOLUTE Mode

ZERO

Displayed value can be cleared (zero-set) at the desired position.
Can be used only when the unit is in Incremental Mode.

DIR

Reverses the direction of measurement.

PRE

Desired value can be preset as a displayed value. A ± sign can also be set.

HOLD

Holds the displayed value. When this function is released, the display reverts to displaying the current true position.

M-SPC

The main unit features an output connector, which allows connection with the DP-1VR digimatic mini processor or other devices. When the DP-1VR is connected, various statistical analysis processing, creation of histograms, and printing can be performed.

Dia.

The doubled scale displacement can be displayed. This convenient feature can be used to display the diameter of workpieces being machined on a lathe.

E

If a position reading cannot be displayed due to noise or other reasons, an error is displayed.

B

B is displayed when battery voltage becomes low, indicating that the battery needs to be replaced soon.

ABSOLUTE Coolant-proof Digimatic Scale Units



Horizontal single function type



IP66

Inch type, Inch/Metric switching type, or Metric type can be selected.

FUNCTION **ORIGIN** **ZERO** **M-SPC**^{*1} **E** **B**

SPECIFICATIONS

Inch	Order No.	572-610	572-611	572-612
	Range	0-4"	0-6"	0-8"
	Accuracy ^{*2}	.001"	.001"	.001"
Inch / Metric	Order No.	572-613	572-614	572-615
	Range	0-4"	0-6"	0-8"
	Accuracy ^{*2}	0.03mm/.001"	0.03mm/.001"	0.03mm/.001"
Metric	Order No.	572-600	572-601	572-602
	Range	0-100mm	0-150mm	0-200mm
	Accuracy ^{*2}	0.03mm	0.03mm	0.03mm
Dimensions	L1 / L2	209mm/185mm	259mm/235mm	311mm/287mm
	Mass	390g	410g	430g

*1 Only connecting cables with an output switch dedicated for ABSOLUTE Coolant-proof Digimatic Scale Units (No.05CZA624/1m, No.05CZA625/2m) can be used.



*2 Not including quantizing error ± 1 count

*3 High slider speed does not cause data errors. Position feedback and output data may not be used while the slider is moving.

*4 Patents registered in Japan, the USA, and Europe (Germany, the UK, France, and Switzerland), patents pending in India and China.

*5 Protection code: IP66. This product is not waterproof. (Anti-corrosion treatment is required after use.)

*6 Tapped insert: No.5-40 UNC (Inch type, Inch/Metric switching type) / 2-M3x0.5 (Metric type) Screwed depth on the rear side of display unit: under 2mm

Protection	Level	Description
Protection against the ingress of foreign bodies	6: Dustproof	Complete protection against ingress of dust
Protection against the ingress of water	6: Water resistant	A powerful water jet directed at the enclosure from any direction has no harmful effect

COMMON SPECIFICATIONS

Resolution: 0.01mm or 0.0005"/0.01mm

Repeatability: 0.01mm

Response speed^{*3}: Unlimited

Length standard: ABSOLUTE electromagnetic induction encoder^{*4}

Dust/Water protection level^{*5}: IP66

Battery: SR44 (1pc., 938882)

Battery life: Approx. 1.5 years under normal use

DIMENSIONS Unit:mm

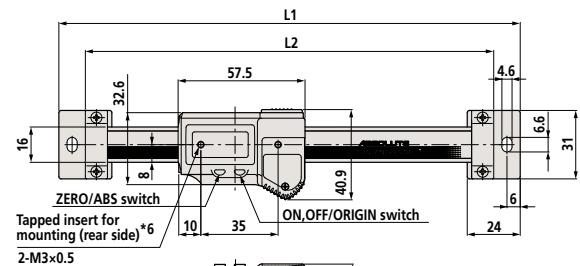

What is electromagnetic induction?

- Current I1, which changes with time, flows through coil L1, generating a magnetic field around coil L1 and adjacent coil L2.
- A voltage V2 is induced in L2 which causes a current I2 to flow in the direction that opposes change in the magnetic field.

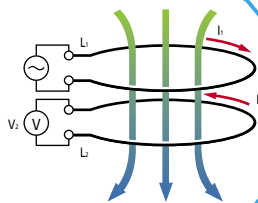

This principle is applied to ABSOLUTE Coolant Proof Digimatic Scales. The induction between coils offers excellent water resistance and oil resistance. Absolute detection is achieved by synthesizing position data with arrangements of two-row graduations on the main scale.

ABSOLUTE Digimatic Scale Units



Horizontal single function type



Either Inch/Metric switching type or Metric type can be selected.

FUNCTION **ORIGIN** **ZERO** **HOLD**^{*1} **M-SPC**^{*2} **E** **B**

SPECIFICATIONS

Inch / Metric	Order No.	572-210-20	572-211-20	572-212-20	572-213-10
Range		0-4"	0-6"	0-8"	0-12"
Accuracy ^{*3}		0.03mm/.001"	0.03mm/.001"	0.03mm/.001"	0.04mm/.002"
Metric	Order No.	572-200-20	572-201-20	572-202-20	572-203-10
Range		0-100mm	0-150mm	0-200mm	0-300mm
Accuracy ^{*3}		0.03mm	0.03mm	0.03mm	0.04mm
Dimensions	L1 / L2	209mm/185mm	259mm/235mm	311mm/287mm	444mm/420mm
Mass		235g	255g	275g	370g

COMMON SPECIFICATIONS

Resolution: 0.01mm or 0.0005"/0.01mm
 Repeatability: 0.01mm or 0.0005"/0.01mm
 Response speed: Unlimited^{*4}
 Length standard: ABSOLUTE electrostatic capacitance type linear encoder
 Battery: SR44 (1pc. 938882)
 Battery life: Approx. 3.5 years under normal use

DIMENSIONS Unit:mm

572-200-20~572-202-20
 572-210-20~572-212-20

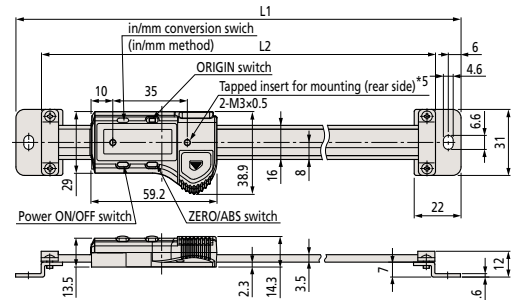

572-203-10, 572-213-10

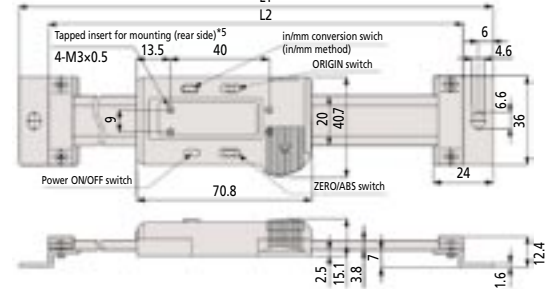

Vertical single function type



Either Inch/Metric switching type or Metric type can be selected.

FUNCTION **ORIGIN** **ZERO** **HOLD**^{*1} **M-SPC**^{*2} **E** **B**

SPECIFICATIONS

Inch / Metric	Order No.	572-310-10	572-311-10	572-312-10	572-313-10
Range		0-4"	0-6"	0-8"	0-12"
Accuracy ^{*3}		0.03mm/.001"	0.03mm/.001"	0.03mm/.001"	0.04mm/.002"
Metric	Order No.	572-300-10	572-301-10	572-302-10	572-303-10
Range		0-100mm	0-150mm	0-200mm	0-300mm
Accuracy ^{*3}		0.03mm	0.03mm	0.03mm	0.04mm
Dimensions	L1 / L2	244mm/220mm	294mm/270mm	344mm/320mm	444mm/420mm
Mass		235g	255g	275g	370g

COMMON SPECIFICATIONS

Resolution: 0.01mm or 0.0005"/0.01mm
 Repeatability: 0.01mm or 0.0005"/0.01mm
 Response speed: Unlimited^{*4}
 Length standard: ABSOLUTE electrostatic capacitance type linear encoder
 Battery: SR44 (1pc. 938882)
 Battery life: Approx. 3.5 years under normal use

DIMENSIONS Unit:mm

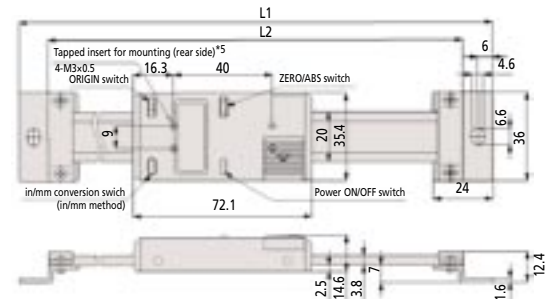

OPTIONAL ACCESSORIES

Hold switch



959143

Connecting cable with output switch



1m:959149
 2m:959150

^{*1} A hold switch (No. 959143), an optional accessory, is required. The output function cannot be used at the same time.
^{*2} Connecting cables on page 3 and connecting cables with output switch (No. 959149/1m and No. 959150/2m) can be used.
^{*3} Not including quantizing error ± 1 count
^{*4} High slider speed does not cause data errors. Position feedback and output data may not be used while the slider is moving.
^{*5} Tapped insert: No.5-40 UNC (Inch/Metric switching type) / 4-M3x0.5 (Metric type) Screwed depth on the rear side of display unit: under 2mm

Horizontal multi-function type



Either Inch/Metric switching type or Metric type can be selected.

FUNCTION ORIGIN ZERO PRE DIR HOLD M-SPC E B

SPECIFICATIONS

Inch / Metric	Order No.	572-470	572-471	572-472	572-473	572-474	572-475	572-476	572-477
	Range	0-4"	0-6"	0-8"	0-12"	0-18"	0-24"	0-32"	0-40"
	Accuracy *1	0.03mm/.001"	0.03mm/.001"	0.03mm/.001"	0.04mm/.002"	0.04mm/.002"	0.05mm/.002"	0.06mm/.0025"	0.07mm/.0025"
Metric	Order No.	572-460	572-461	572-462	572-463	572-464	572-465	572-466	572-467
	Range	0-100mm	0-150mm	0-200mm	0-300mm	0-450mm	0-600mm	0-800mm	0-1000mm
	Accuracy *1	0.03mm	0.03mm	0.03mm	0.04mm	0.04mm	0.05mm	0.06mm	0.07mm
Dimensions	L1 / L2	244mm/220mm	294mm/270mm	344mm/320mm	444mm/420mm	594mm/570mm	774mm/750mm	974mm/950mm	1174mm/1150mm
	t / G / H					6mm/23.2mm/14.6mm		10mm/27.2mm/18.6mm	
	Mass	250g	280g	310g	370g	760g	900g	1710g	2040g

COMMON SPECIFICATIONS

Resolution: 0.01mm or 0.0005"/0.01mm

Repeatability: 0.01mm or 0.0005"/0.01mm

Response speed*2: Unlimited

Length standard: ABSOLUTE electrostatic capacitance type linear encoder

Battery: SR44 (1pc. 938882)

Battery life: Approx. 5000 hours in continuous use

DIMENSIONS Unit:mm

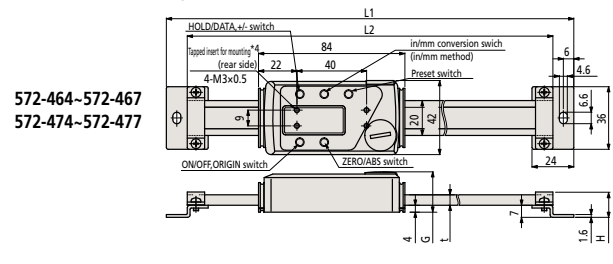
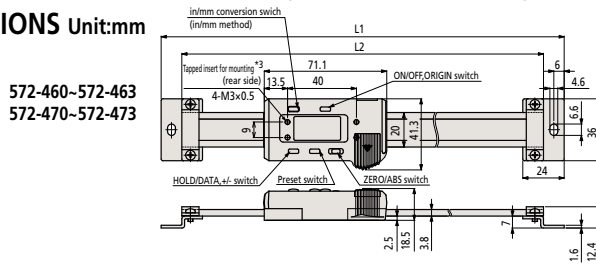

Vertical multi-function type



Either Inch/Metric switching type or Metric type can be selected.

FUNCTION ORIGIN ZERO PRE DIR HOLD M-SPC E B

SPECIFICATIONS

Inch / Metric	Order No.	572-570	572-571	572-572	572-573	572-574	572-575	572-576	572-577
	Range	0-4"	0-6"	0-8"	0-12"	0-18"	0-24"	0-32"	0-40"
	Accuracy *1	0.03mm/.001"	0.03mm/.001"	0.03mm/.001"	0.04mm/.002"	0.04mm/.002"	0.05mm/.002"	0.06mm/.0025"	0.07mm/.0025"
Metric	Order No.	572-560	572-561	572-562	572-563	572-564	572-565	572-566	572-567
	Range	0-100mm	0-150mm	0-200mm	0-300mm	0-450mm	0-600mm	0-800mm	0-1000mm
	Accuracy *1	0.03mm	0.03mm	0.03mm	0.04mm	0.04mm	0.05mm	0.06mm	0.07mm
Dimensions	L1 / L2	244mm/220mm	294mm/270mm	344mm/320mm	444mm/420mm	594mm/570mm	774mm/750mm	974mm/950mm	1174mm/1150mm
	t / G / H					6mm/23.2mm/14.6mm		10mm/27.2mm/18.6mm	
	Mass	250g	280g	310g	370g	760g	900g	1710g	2040g

COMMON SPECIFICATIONS

Resolution: 0.01mm or 0.0005"/0.01mm

Repeatability: 0.01mm or 0.0005"/0.01mm

Response speed*2: Unlimited

Length standard: ABSOLUTE electrostatic capacitance type linear encoder

Battery: SR44 (1pc. 938882)

Battery life: Approx. 5000 hours in continuous use

DIMENSIONS Unit:mm

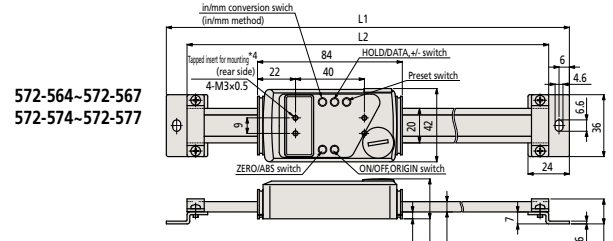
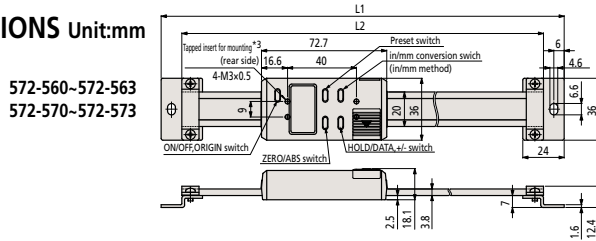

*1 Not including quantizing error ±1 count

*2 High slider speed does not cause data errors. Position feedback and output data may not be used while the slider is moving.

*3 Tapped insert: No.5-40 UNC (Inch/Metric switching type) / 4-M3x0.5 (Metric type) Screwed depth on the rear side of display unit: under 2mm

*4 Tapped insert: No.5-40 UNC (Inch/Metric switching type) / 4-M3x0.5 (Metric type) Screwed depth on the rear side of display unit: under 3mm



Horizontal multi-function type with diameter display function

Made-to-order products



Either Inch/Metric switching type or Metric type can be selected.

FUNCTION ORIGIN ZERO PRE HOLD M-SPC Dia. E B

SPECIFICATIONS

Inch / Metric	Order No.	572-490-10	572-491-10	572-492-10	572-493-10	572-494-10	572-495-10	572-496-10	572-497-10
	Range	0-4"	0-6"	0-8"	0-12"	0-18"	0-24"	0-32"	0-40"
Metric	Order No.	572-480-10	572-481-10	572-482-10	572-483-10	572-484-10	572-485-10	572-486-10	572-487-10
	Range	0-100mm	0-150mm	0-200mm	0-300mm	0-450mm	0-600mm	0-800mm	0-1000mm
	Accuracy *1	0.03mm	0.03mm	0.03mm	0.04mm	0.04mm	0.05mm	0.06mm	0.07mm
Dimensions	L1 / L2	244mm/220mm	294mm/270mm	344mm/320mm	444mm/420mm	594mm/570mm	774mm/750mm	974mm/950mm	1174mm/1150mm
	t / G / H					6mm/23.2mm/14.6mm	10mm/27.2mm/18.6mm		
	Mass	250g	280g	310g	370g	760g	900g	1710g	2040g

COMMON SPECIFICATIONS

Resolution: 0.01mm or 0.0005"/0.01mm

Repeatability: 0.01mm or 0.0005"/0.01mm (Radius indication, not diameter)

Response speed*2: Unlimited

Length standard: ABSOLUTE electrostatic capacitance type linear encoder

Battery: SR44 (1pc. 938882)

Battery life: Approx. 5000 hours in continuous use

DIMENSIONS Unit:mm

572-480-10~572-483-10
572-490-10~572-493-10

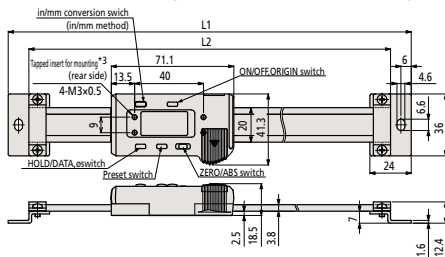

572-483-10~572-487-10
572-494-10~572-497-10

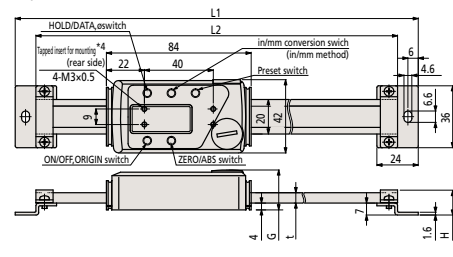

Vertical multi-function type with diameter display function

Made-to-order products



Either Inch/Metric switching type or Metric type can be selected.

FUNCTION ORIGIN ZERO PRE HOLD M-SPC Dia. E B

SPECIFICATIONS

Inch / Metric	Order No.	572-590-10	572-591-10	572-592-10	572-593-10	572-594-10	572-595-10	572-596-10	572-597-10
	Range	0-4"	0-6"	0-8"	0-12"	0-18"	0-24"	0-32"	0-40"
Metric	Order No.	572-580-10	572-581-10	572-582-10	572-583-10	572-584-10	572-585-10	572-586-10	572-587-10
	Range	0-100mm	0-150mm	0-200mm	0-300mm	0-450mm	0-600mm	0-800mm	0-1000mm
	Accuracy *1	0.03mm	0.03mm	0.03mm	0.04mm	0.04mm	0.05mm	0.06mm	0.07mm
Dimensions	L1 / L2	244mm/220mm	294mm/270mm	344mm/320mm	444mm/420mm	594mm/570mm	774mm/750mm	974mm/950mm	1174mm/1150mm
	t / G / H					6mm/23.2mm/14.6mm	10mm/27.2mm/18.6mm		
	Mass	250g	280g	310g	370g	760g	900g	1710g	2040g

COMMON SPECIFICATIONS

Resolution: 0.01mm or 0.0005"/0.01mm

Repeatability: 0.01mm or 0.0005"/0.01mm (Radius indication, not diameter)

Response speed*2: Unlimited

Length standard: ABSOLUTE electrostatic capacitance type linear encoder

Battery: SR44 (1pc. 938882)

Battery life: Approx. 5000 hours in continuous use

DIMENSIONS Unit:mm

572-480-10~572-583-10
572-490-10~572-593-10

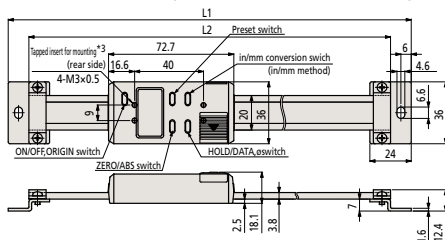

572-584-10~572-587-10
572-594-10~572-597-10

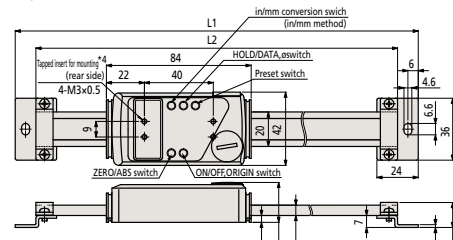

*1 Not including quantizing error ±1 count

*2 High slider speed does not cause data errors. Position feedback and output data may not be used while the slider is moving.

*3 Tapped insert: No.5-40 UNC (Inch/Metric switching type) / 4-M3x0.5 (Metric type) Screwed depth on the rear side of display unit: under 2mm

*4 Tapped insert: No.5-40 UNC (Inch/Metric switching type) / 4-M3x0.5 (Metric type) Screwed depth on the rear side of display unit: under 3mm

Display Unit

EC counter

FEATURES

This Digimatic Display Unit with GO/NG judgement function offers a large, easily read display for a Digimatic Scale Unit. The bright LED readout is ideal for low-light situations or when the scale unit must be located where its own display cannot be viewed directly.

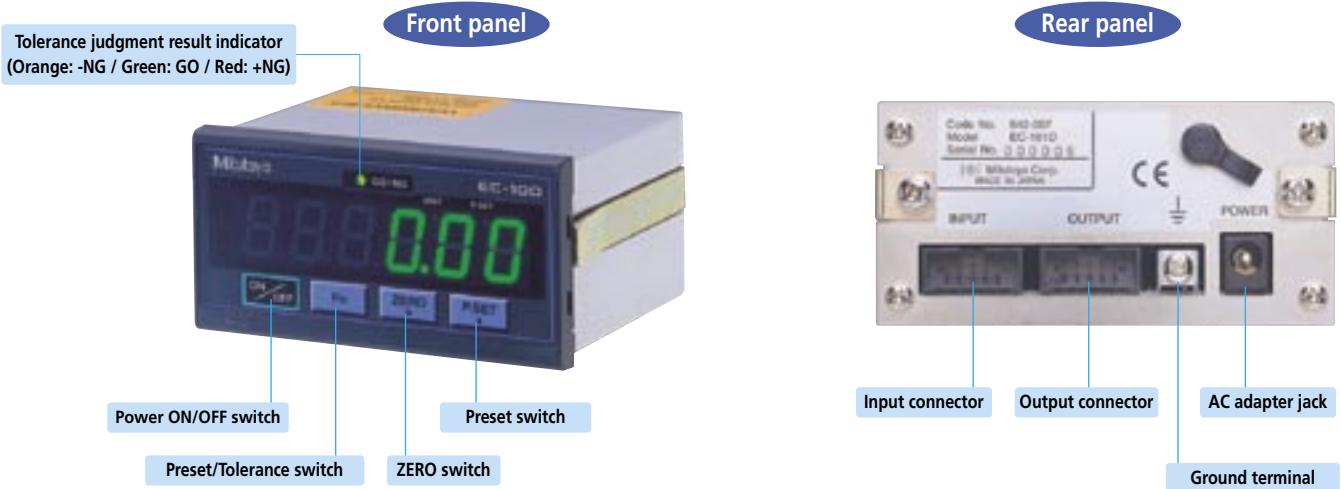

SPECIFICATIONS

Order No.	542-007 ^{*1}	
Resolution	0.01mm(±9999.99mm)	
	.0005" (±99.9995") / .001" (±999.99")	
Display	0.001mm(±999.999mm)	
	.00005" (±9.99995") / .0001" (±99.999")	
Display	Display of + and - signs and 6-digit measurement data	
Tolerance judgment result indicator	LED (Orange, Green, Red)	
Output (switching control)	tolerance judgment results output	-NG / GO / +NG (open-collector output)
	data output	Digimatic
Input	Preset, HOLD	
Power Supply	AC adapter ^{*1}	
Operating temperature	0°C to 40°C	
Storage temperature	-10°C to 50°C	
Mass	220g	

*1 Standard accessory

The dedicated AC adapter AD908 is supplied with one of the following, according to the order number.

- 542-007:AD908N(No.526688)(for Japan)
- 542-007A:AD908AN(No.526688A)(for USA)
- 542-007D:AD908AD(No.526688D)(for EU)
- 542-007E:AD908EN(No.526688E)(for UK)
- 542-007DC:AD908DC(No.526688DC)(for China)
- 542-007K:AD908K(No.526688K)(for Korea)

Optional accessories

- Connecting cables: 936937(1m),965014(2m)
- DC plug PJ-2: 214938
- Connecting cable: C162-155(2m)

DIMENSIONS Unit:mm

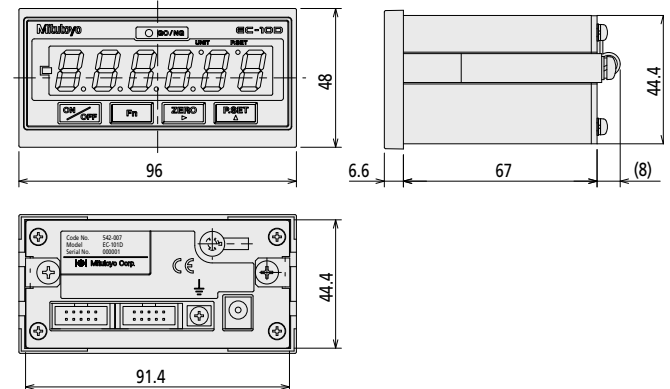

Output connector specifications

The output can be switched to either the tolerance judgment I/O or Digimatic output.

The following shows the detailed specifications when the tolerance judgment I/O is selected.

(1) Connecting cable: C162-155(2m)

(2) Output connector pin assignment

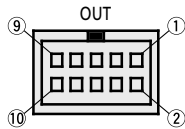

Pin No.	I/O	Signal name	Function	Color of the lead wire in the optional I/O cable
1		COM	Connection to internal GND	Brown,Black
2	O	+NG	Tolerance output: Relevant pin output is low level. When an error is displayed: +NG and -NG pins are low level.	Brown,Red
3	O	GO		Yellow,Black
4	O	-NG		Yellow,Red
5	I	HOLD	HOLD input	Green,Black
6	I	P.SET	Preset input	Green,Red
10		F.G.	Shield (internally connected to the case)	White,Red
Leave the other pins unconnected.				

Note that the output functions of the connector pins are different for the Digimatic output mode. The I/O cable should be connected after the output mode is set.

The free end of the I/O cable terminates in seven wires which have to be connected according to purpose. Connect the F.G. line (with solderless terminals) to the ground terminal of the equipment to be connected.

Timing chart

Tolerance output

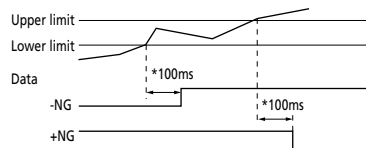

Preset and HOLD inputs

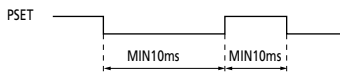

*Preset and HOLD input signals are active low.

(3) I/O circuit

a. Output circuit (-NG / GO / +NG)

The transistor is on during open-collector output at low level.

Maximum applied voltage = 24VDC
Maximum sink current = 10mA
Maximum saturation voltage = 0.7VDC

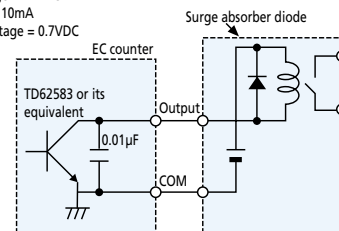

b. Input circuit (Preset, HOLD)

Input is valid at "low" level.

Maximum source current = 1mA
Input voltage: High level = 4-24VDC
Low level = 1VDC maximum

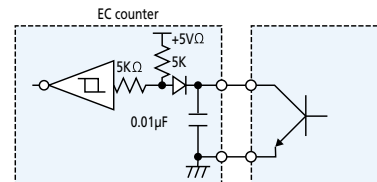

Reference circuit for external devices.
Use open-collector output, relay output, or the like.

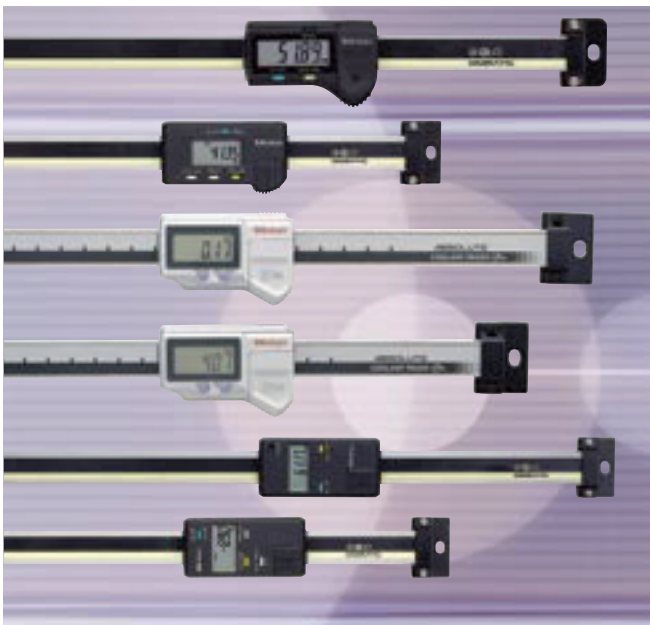

Our products are classified as regulated items under Japanese Foreign Exchange and Foreign Trade Law. Please consult us in advance if you wish to export our products to any other country. If the purchased product is exported, even though it is not a regulated item (Catch-All controls item), the customer service available for that product may be affected. If you have any questions, please consult your local Mitutoyo sales office.

- Test Equipment and Seismometers
- Digital Scale and DRO Systems
- Small Tool Instruments and Data Management

Note: All information regarding our products, and in particular the illustrations, drawings, dimensional and performance data contained in this pamphlet, as well as other technical data are to be regarded as approximate average values. We therefore reserve the right to make changes to the corresponding designs, dimensions and weights. The stated standards, similar technical regulations, descriptions and illustrations of the products were valid at the time of printing. Only quotations submitted by ourselves may be regarded as definitive.

Our products are classified as regulated items under Japanese Foreign Exchange and Foreign Trade Law. Please consult us in advance if you wish to export our products to any other country. If the purchased product is exported, even though it is not a regulated item (Catch-All controls item), the customer service available for that product may be affected. If you have any questions, please consult your local Mitutoyo sales office.

Mitutoyo Nederland b.v.
 Storkstraat 40
 3905 KX Veenendaal
 T 0031 318 534911
 F 0031 318 534811
 sales@mitutoyo.nl
 www.mitutoyo.nl

